

**Oakley Sound Systems**

**Stereo Ensemble – SRE330**

**Main Board Issue 2**

**Builder's Guide**

**V2.12**

Tony Allgood  
Oakley Sound Systems  
CARLISLE  
United Kingdom

# Introduction

This is the Builder's Guide for the Stereo Ensemble Module SRE330 from Oakley Sound. This document contains a basic introduction to the three circuit boards used to make the SRE330 rack module and a full parts list for all the components needed to populate the board or boards.

For the User Manual, which contains an overview of the unit, the operation of the module and the calibration procedure, please visit the main project webpage at:

<http://www.oakleysound.com/sre330.htm>

For general information regarding where to get parts and suggested part numbers please see our useful Parts Guide at the project webpage or <http://www.oakleysound.com/parts.pdf>.

For general information on how to build our modules, including circuit board population, mounting front panel components and making up board interconnects please see our generic Construction Guide at the project webpage or <http://www.oakleysound.com/construct.pdf>.



*The first prototype unit built into a Bryant Broadcast 1U 250mm deep 19" rack enclosure with the Schaeffer front panel attached. This one used an earlier issue 1 RPSU power module. Issue 2 RPSU boards are green and use a five way 0.156" connector to take power onto the SRE330 main board.*

# Constructing the SRE330

The SRE330 project uses the SRE330 main board, the optional SREIO input/output board and the RPSU +/-15V power supply module.

The SRE330 main board requires a well regulated and quiet +/-15V to +/-16V supply. The current taken by the SRE330 varies slightly with modulation depth but the maximum current is around +225mA and -180mA. Power is admitted onto the main board via a 5-way Molex 0.156" KK or 5-way 0.156" MTA connector. Pin 1 is +15V, pin 2 and 3 are 0V, pin 4 is -15V and pin 5 is panel ground. Panel ground is typically connected to 0V at either the power supply or the input/output sockets. On the SRE330 main board Pin 5 connects only to the pot brackets and switches' metal supporting tangs.

The SRE330 is a large board at 389mm wide and 153mm deep. It is secured to the front panel by the pot brackets and to the lower panel of the case with three M3 screws and spacers. The board has four copper layers, the top and bottom copper layers carry signals, the top middle layer carries power supplies and some signals, and the bottom middle layer is solely designated to 0V. A four layer design, although expensive to produce, gives better performance than standard two layer board designs. It is, however, imperative that when soldering, and especially desoldering, that the through hole plating used to line all the solder pad holes is not damaged. If you do need to desolder a part then either use a proper vacuum desoldering tool or cut the component body out first and then desolder one component leg at a time.

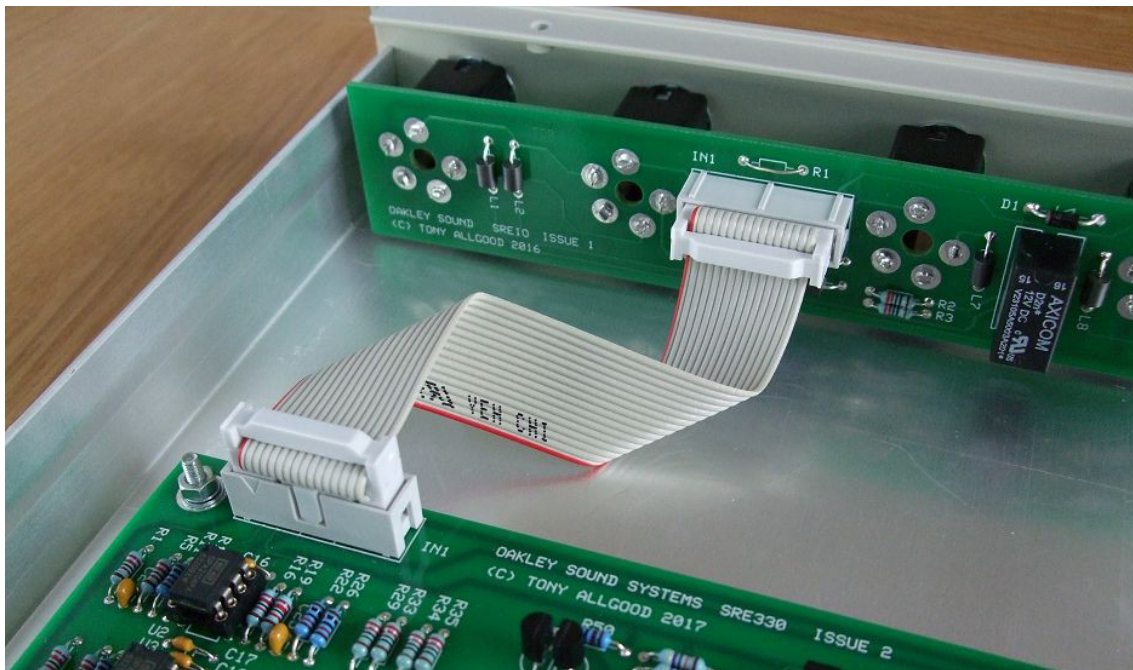

*The 16-way ribbon cable used to transfer the balanced audio signals between the SRE330 main board and the SREIO socket board.*

The SREIO board is an input and output socket board designed for this project. It allows the simple interconnection between the SRE330 main board and the audio sockets via a single 16-way 0.05" IDC ribbon cable. The SREIO board also features a electromechanical relay to cut the connection between the main board's output circuitry and the output sockets at power on and power off. This reduces the likelihood of damaging thumps on the audio output when power is turned on and off.

The anti-thump circuitry is powered from the main power supply module via a three way 0.156" Molex or MTA connector. Pin 1 is +15V and pin 3 is 0V. Pin 2 can be used to 'ground' the sockets' earth lug to the power supply's 0V if desired although this is not normally needed in most SRE330 builds.

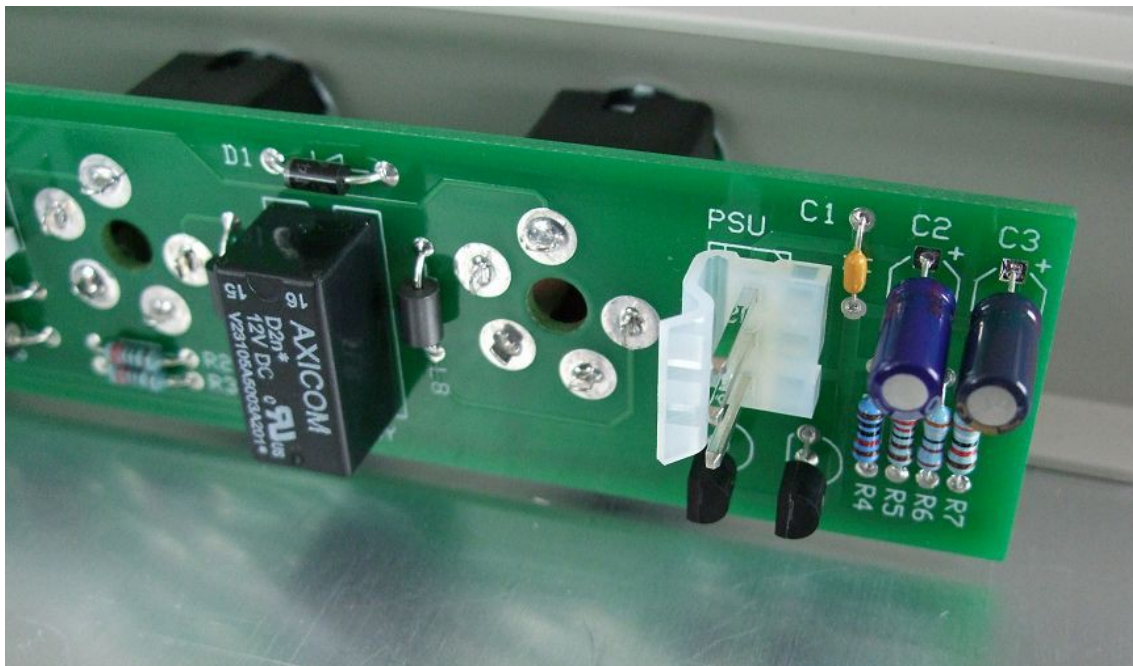

*The relay and power muting circuitry on the SREIO board.*

The SREIO board is 34mm high and 185mm wide. It is a two layer design. The sockets used are the industry standard 1/4" TRS (Tip Ring Sleeve) socket, the Switchcraft 114BCPX. Various clones of this socket are available but arguably Switchcraft still make the best version.

The RPSU is a power supply module designed specifically for the SRE330, although it is likely that other future Oakley Sound rack projects will use this module too. It generates +/-15.3V at up to around 1A given sufficient heatsinks and a suitable mains transformer. The SRE330 only needs less than 250mA but even so adequate heatsinking must be used for the two power devices. Since best performance for any electronic audio device comes from using a metal case it makes sense to use the case itself as a heatsink. Details on how to do this are given later in this document.

Although the RPSU can be used with an internal mains transformer, I recommend that builders use an external low voltage output line lump or wallwart type mains adapter. This keeps all the high voltages away from your project and ensures your safety. An example of such is the Yamaha PA-20 which is available from all larger music stores. Later on in this document I will give details on how to build your RPSU module to suit your chosen method of supplying power.

The RPSU is 150mm by 51mm in size. It is a two layer board and made from double thickness copper to reduce unwanted voltage drops along the copper traces on the board. Unlike the issue 1 RPSU board there are no trimmers to set the voltages to exactly +/-15.00V. The SRE330 main board's circuitry is not bothered whether the voltage is exactly 15.00V but only that it doesn't change once the SRE330 main board has been calibrated. The RPSU board thus needs no trimmers and produces a little over +/-15.3V when built as recommended.

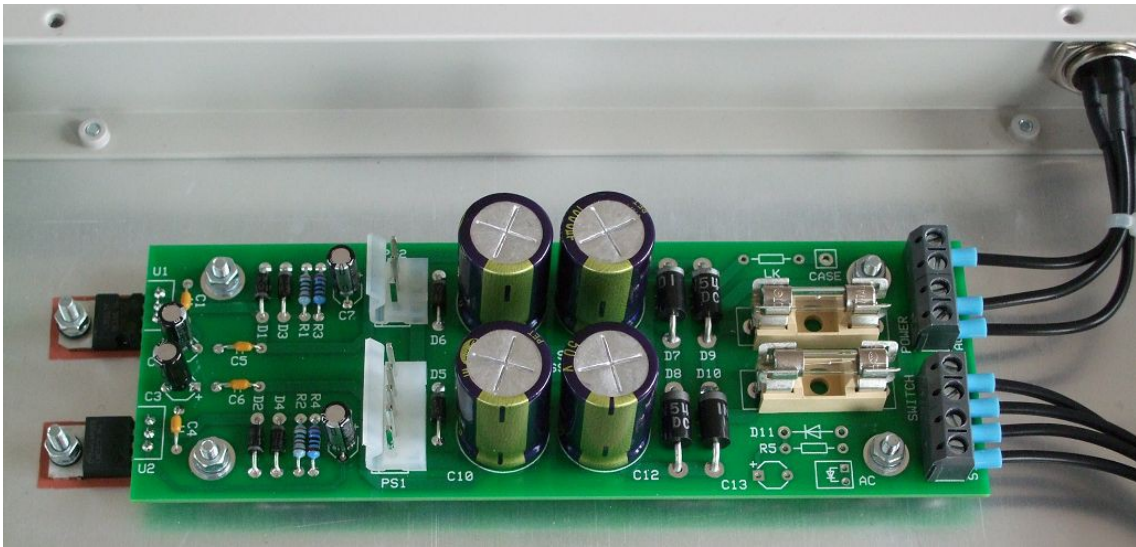

*The issue 2 RPSU wired for use with a Yamaha PA-20 external power supply.*

The RPSU requires an AC supply of a minimum of 15V to work correctly. When used with a centre tapped AC supply, such as that from the PA20 or internal mains transformer, the current taken is approximately 0.4A (RMS). With a single phase supply, such as that from a standard AC output wallwart supply, the current required will be in the order of 0.7A (RMS).



*The three way power socket that will fit the Yamaha PA20 power supply.*

## Parts Lists

For general information regarding where to get parts and suggested part numbers please see our useful Parts Guide at the project webpage or directly from <http://www.oakleysound.com/parts.pdf>.

The components are grouped into values, the order of the component names is of no particular consequence. Component values given in this list supersede those shown on the schematic.

A quick note on European part descriptions. R is shorthand for ohm. K is shorthand for kilo-ohm. So 22R is 22 ohm, 1K5 is 1,500 ohms or 1.5 kilohms. For capacitors: 1uF = one microfarad = 1000nF = one thousand nanofarad.

To prevent loss of the small '.' as the decimal point, a convention of inserting the unit in its place is used. eg. 4R7 is a 4.7 ohm, 4K7 is a 4,700 ohm resistor, 6n8 is a 6.8 nF capacitor.

## SRE330 Main Board issue 2 Parts List

### Resistors

All resistors should be 1% 0.25W metal film resistors except for R57 which can be 5% metal film or carbon.

22R	R40
75R	R37, R36, R203, R257, R181, R227
120R	R38, R39, R52
220R	R34, R33, R29, R35
390R	R151, R91, R87, R139, R136, R148, R78, R84, R53
510R	R54
1K	R56
2K2	R44
3K3	R200, R254, R224, R260, R178
3K9	R4, R24
4K7	R119, R162, R238, R189, R60, R211
6K8	R186, R121, R50, R108, R164, R191, R165, R62, R214, R51, R240, R107
10K	R26, R14, R198, R13, R22, R184, R11, R12, R41, R95, R177, R43, R182, R82, R167, R223, R176, R68, R190, R205, R222, R253, R199, R27, R196, R23, R252, R83, R67, R71
11K	R174, R220, R251, R185, R166, R197
15K	R127, R175, R21, R66, R134, R231, R152, R90, R163, R76, R131, R70, R98, R3, R103, R137, R135, R77, R244, R160, R45
22K	R2, R6, R86, R20, R19, R16, R75, R132, R89, R17, R28, R155, R5, R94, R74, R1, R73, R81, R97
30K	R173, R172
33K	R217, R256, R79, R246, R92, R242, R193, R250, R169, R180, R259, R15, R55, R25, R202, R234, R226
36K	R249, R261
39K	R221, R239

47K	R208, R209, R63, R122, R30, R216, R31, R245, R8, R18, R42, R192, R64, R109, R49, R124, R7, R154, R48, R105, R158, R168, R207, R157, R150, R9
51K	R235, R229, R228, R243, R241, R233, R212, R215
56K	R123, R102, R141, R113, R32, R10
100K	R218, R46, R183, R128, R247, R69, R100, R99, R187, R111, R213, R236, R248, R204, R219, R230, R130, R147, R145, R195, R194, R159, R142, R171, R170, R206, R116, R232, R258
120K	R161, R106, R125, R237, R188, R65, R47, R210
150K	R225, R255, R201, R179
330K	R110, R129, R104, R146
390K	R144, R112, R149, R153, R156, R114
470K	R138, R115, R61, R133, R58, R59, R126, R140, R143, R120, R117, R118, R101
820K	R88, R93, R96
1M	R72, R80, R85
3M3	R57

## Capacitors

10pF C0G 2.5mm ceramic	C14, C28
22pF C0G 2.5mm ceramic	C8, C21
33pF C0G 2.5mm ceramic	C169, C184, C195, C190
56pF C0G 2.5mm ceramic	C181, C122, C92, C155
100pF C0G 2.5mm ceramic	C25, C166, C52, C26, C138, C80, C189, C57, C2, C103, C3, C75
220pF C0G 2.5mm ceramic	C112, C20, C29, C102, C27, C142, C165, C113, C101, C137, C121, C15, C188, C136
1nF C0G 2.5mm ceramic	C93, C182, C156, C123
1n5 100V polyester	C158, C97, C117, C185, C91, C128
2n2 100V polyester	C139, C191, C111, C100, C167, C106
10nF 63V polyester	C41
22nF 63V polyester	C140, C192, C168, C84, C107
47nF 63V polyester	C72, C82, C83
100nF 63V polyester	C40, C60, C62
220nF 63V polyester	C51, C58, C59
470nF 63V polyester	C86, C172, C151, C87, C61, C150, C171, C116, C115, C70, C50, C43
1uF 63V polyester	C9, C5, C1, C149, C37, C131, C108, C39, C146, C143, C148, C125, C32, C147
2u2 50V polyester	C4, C10, C170, C180
100nF axial multilayer ceramic	C68, C67, C76, C66, C187, C35, C63, C73, C53, C46, C54, C79, C164, C56, C129, C193, C96, C95, C160, C176, C99, C98, C183, C162, C130, C94, C77, C174, C78, C159, C44, C124, C194, C45, C47, C186, C16, C18, C19, C17, C114, C64, C22, C81, C85, C48, C13, C105, C24, C49, C12, C23,

C104, C141, C161, C36, C65, C55, C74, C175, C173, C163, C157

2u2, 63V electrolytic  
4u7, 50V electrolytic

C178, C177, C152, C88, C153, C89, C118, C31, C119  
C109, C110, C30, C33, C144, C126, C145, C133, C132, C6, C11, C127

10uF, 35V electrolytic  
47uF, 35V electrolytic

C7, C135, C69, C71, C42, C134, C34  
C154, C120, C90, C179, C38

### Integrated Circuits

TL072CP dual FET op-amp

U47, U20, U45, U6, U13, U10, U25, U37, U42, U50, U21, U27, U14, U15, U26, U18, U9, U8, U31, U54, U22

OPA2134PA dual op-amp  
NE5532AP dual audio op-amp  
V571D or NE570 compander

U48, U46, U3, U2, U1  
U30, U34, U5  
U35, U40, U4

V3102D BBD driver

U44, U39, U52, U33

V3207D BBD

U51, U32, U38, U43

LM13700N dual OTA

U12, U24, U7, U19

LM2901N quad comparator

U11

DG403DJ dual analogue switch

U55, U23, U16, U17, U53, U28

78L09 +9V regulator 100mA

U29, U36, U41, U49

The Belling BL3207 or Panasonic MN3207 may be used instead of the Coolaudio V3207.

IC sockets are recommended for the V571D, V3102D, V3207D and LM13700N even if you don't socket any of the other ICs.

### Discrete Semiconductors

BC549C NPN transistor

Q9, Q8, Q14, Q10, Q15, Q12, Q13, Q11

BC559C PNP transistor

Q5, Q7, Q4, Q6, Q3, Q2, Q1

1N4148 signal diode

D16, D22, D24, D10, D25, D23, D20, D26, D18, D19, D15, D11, D6, D12, D7, D21, D9, D17

1N5819 diode

D13, D14

BZX55C2V7 2V7 zener diode

D1, D2, D3, D4

BAT42 Schottky diode

D5, D8

3 mm red LED

PK

3 mm yellow LED

HI, MD

3 mm green LED

LO, ON



## Trimmers

All trimmers are 6mm types. For example, Bourns 3386F.

5K	NULL1, NULL2, NULL3, NULL4
20K	T_LVL, S_LVL
50K	FAST, SLOW, OFF1, OFF2, OFF3, OFF4
100K	S_FRQ, T_FRQ, CLK1, CLK2, CLK3, CLK4

## Pots

All pots 16mm Alpha or Alps types.

50K linear	TRI_RATE, SIN_RATE
50K logarithmic	TRI_DEPTH, SIN_DEPTH
50K dual gang linear	OUT_LEVEL, BALANCE, INPUT

Seven Alpha pot brackets. Seven knobs to suit.

## Switches

SPDT ON-OFF-ON toggle switch	MODE
SPDT ON-ON toggle switch	TYPE, MONO

## Interconnects

5 way Molex 0.156" header	POWER
16 way 2 x 8 IDC box header*	IN1

\* If choosing to hand wire the sockets rather than using the optional SRIO board then you do not need to fit this IDC header. Instead you will wire the sockets to the appropriate solder pads where the header would normally be fitted.

## Miscellaneous

Mounting hardware for the three mounting holes. For the Bryant Broadcast or Holt Broadcast 1U aluminium cases the following hardware can be used.

- M3 hex threaded 6mm spacers (3 off)
- M3 CSK 16mm screws (3 off)
- M3 hex nut (3 off)
- M3 shakeproof washers (6 off)
- M3 flat washers (3 off)

The shakeproof washers go between the bottom panel and the hex spacer, and between the flat washer and the top nut. The flat washer goes up against the top surface of the PCB.

# SREIO Board issue 1 & 2 Parts List

## Important Note

The 1/4" sockets are fitted on the underside of the board. They should be fitted last and soldered from the top side of the board.

## Resistors

All resistors 1% 0.25W metal film resistors.

220R	R2, R3
2K2	R5
3K9	R6
10K	R4
39K	R7

Issue 1: R1 can either be a 0R resistor or simply a wire link made from a resistor lead clipping.

Issue 2: There is no R1 but you need to fit three wire links to positions LK1, LK2 & LK4. The position LK3 must be left empty.

## Capacitors

100nF axial multilayer ceramic	C1
2u2, 63V electrolytic	C2
22uF, 35V electrolytic	C3

## Discrete Semiconductors

1N4004 diode	D1
BC549C NPN transistor	Q1, Q2

## Interconnects

Switchcraft 114BPCX 1/4" socket	IN_A, IN_B, OUT_LEFT, OUT_RIGHT
16 way 2 x 8 IDC box header	IN1
3 way Molex 0.156" header	PSU
16 way 2 x 8 IDC socket	2 off for SREIO to SRE330 interconnect.
16 way 0.05" IDC ribbon cable	Cut to length to fit between SREIO and SRE330 boards

## Miscellaneous

Axial leaded ferrite bead	L1, L2, L3, L4, L5, L6, L7, L8
12V or 15V DPDT relay*	RELAY

\* This relay is an industry standard type such as TE Connectivity part number 8-1393792-8.

## RPSU issue 2 Parts List

### Resistors

All resistors 1% 0.25W metal film resistors.

270R	R3, R4
3K	R1, R2

R5 and LK are not fitted.

### Capacitors

100nF axial multilayer ceramic	C1, C4, C5, C6
10uF, 35V or 50V electrolytic	C2, C3, C7, C8

1000uF, 35V or 50V electrolytic	C9, C10, C11, C12
---------------------------------	-------------------

C9 to C12 are radial types and have standard wire ended leads. Lead spacing is 7.5mm. Do not get 'push-fit' types as their pins would be too large to fit into the PCB. Ensure they have a ripple rating of at least 750mA and that their height doesn't exceed your chosen case once they are fitted into the board.

C13 is not fitted.

### Discrete Semiconductors

1N4002 or 1N4004	D1, D2, D3, D4, D5, D6
1N5401	D7, D8, D9, D10

D11 and AC LED are not fitted.

D9 and D10 do not need to be fitted if you are using a single phase wall wart or line lump, although they won't cause any problems if they are. For full wave rectification, that is, if you are using a split output line lump or an internal transformer with twin secondaries, then D9 and D10 are required.

### Integrated Circuits

LM317T 1A variable regulator	U1
LM337T 1A variable regulator	U2

Ensure that both devices are TO-220 types and not any surface mounting or TO-3 packages. I much prefer the devices that have a thicker mounting (dual gauge) tab.

Do not fit solder U1 and U2 into the board just yet. They are only to be soldered once the board is fitted to the base panel of your case. See the section on mounting the RPSU board later in this document.

## Miscellaneous

0.156" Molex KK 5-way header	PS1
0.156" Molex KK 3-way header	PS2 – if using the SRE I/O board.
0.156" Molex KK 5-way housing	2 off for power cable to main board
0.156" Molex KK 3-way housing	2 off for power cable to SREIO board
0.156" Molex crimps	16 off for power cables
Antisurge 20mm fuse*	F1, F2
20mm fuseholder PC mount*	F1, F2
4-way screw terminal 5mm	POWER, SWITCH

\* If you are using a single phase wall wart supply, then fuseholder F1 and its associating fuse does not need to be fitted. F2's fuse rating should then be a 1A antisurge or time lag type. If you are using an internal transformer or split output line lump supply then both fuseholders are fitted and the fuses are both 800mA antisurge or time lag types.

2 off TO-220 insulator	For mounting of U1 and U2 to panel
2 off TO-220 insulating bush	For mounting of U1 and U2 to panel
Heatsink paste	For mounting of U1 and U2 to panel if using mica plates

Suitable power switch  
Suitable power socket

A suitable length of 24/0.2 insulated cable for all power connections.

Mounting hardware for the four mounting holes. For the Bryant Broadcast or Holt Broadcast 1U aluminium "Joggle" cases the following hardware can be used.

M3 hex threaded 6mm spacers (4 off)  
M3 CSK 16mm screws (4 off)  
M3 hex nut (4 off)  
M3 shakeproof washers (8 off)  
M3 flat washers (4 off)

The shakeproof washers go between the bottom panel and the hex spacer, and between the flat washer and the top nut. The flat washer goes up against the top surface of the PCB.

For mounting the power devices, U1 and U2, you will also need the following parts.

M3 10mm screws (2 off)  
M3 hex nut (2 off)  
M3 shakeproof washers (2 off)

A shim plate may also be required if the lower panel of your case is particularly thin and you wish to use countersunk screws.

Please see later in this document for more details on how to mount the power devices.

## Mounting the Pots and Switches

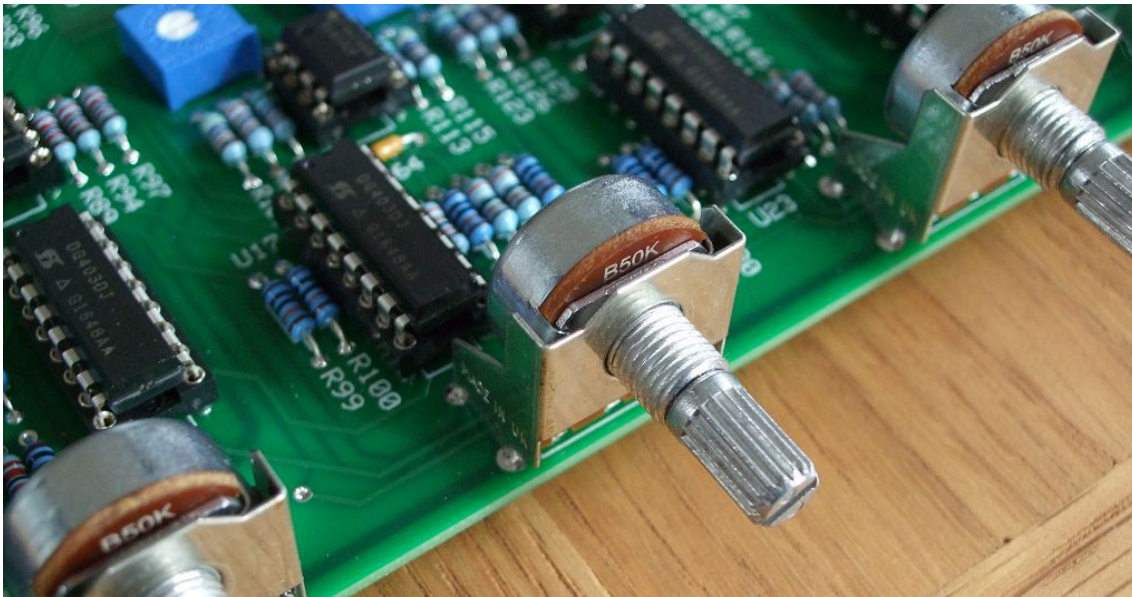

*A close up of the single gang Triangle Modulation Depth pot with its solder bracket.*

If you are using the recommended Alpha pots then they can help support the PCB with the addition of the specially manufactured pot brackets. However, given the large size of the SRE330 PCB it is also necessary to utilise the three additional mounting holes at the rear edge of the board. These holes are sized to take an M3 screw and can be used with suitable hex spacers to attach the PCB directly to the lower panel of your case.

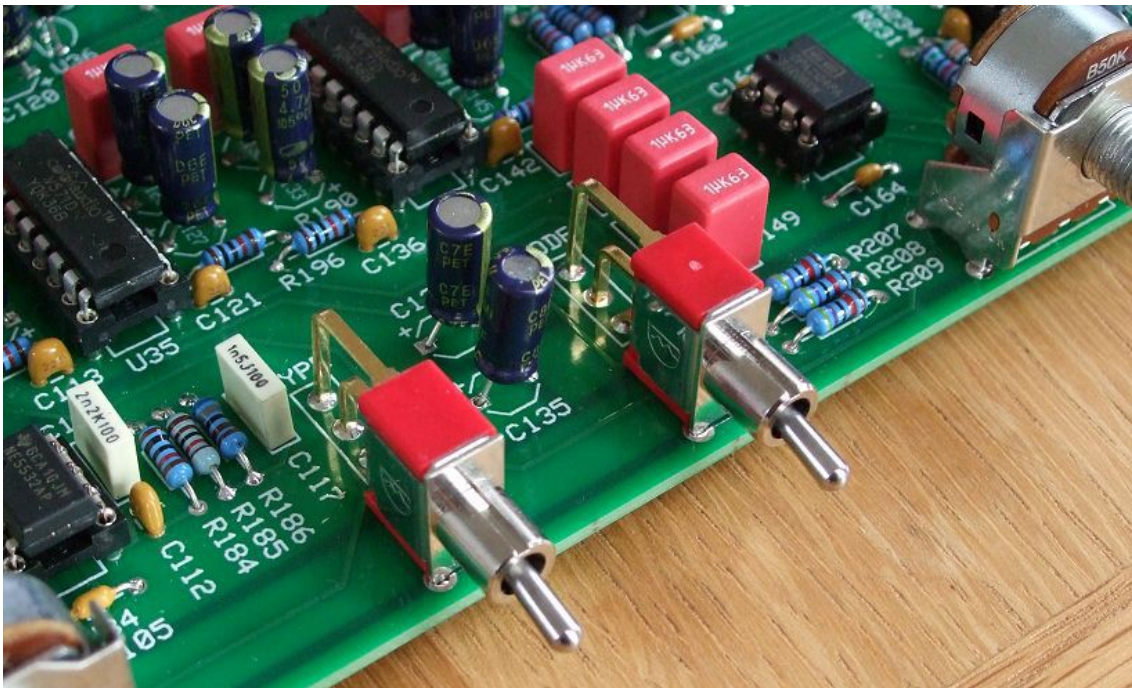

*These switches are Multicom's two position IMS1T2B4M7RE and three position MS3T2B4M7RE. They look identical so make sure you click through their positions to verify which is which before you solder them in place.*

Alpha pots are labelled with an A, B or C prefix. For example: B50K or C10K. Alpha and ALPS

use the key; A = logarithmic, B = linear and C = reverse logarithmic. So a B50K is a 50 kilohm linear pot. You can use 47K in place of a 50K pot.

When constructing the board, temporarily fit the pot brackets to their pots by the nuts and washers supplied with the pots. Now fit the pot and pot bracket assembly into the appropriate holes in the PCB. Solder only the three, or six for the dual gang pots, pins that connect to the pot. **Do not** solder the pot bracket at this stage. When you have soldered all the pot pins you can fit the board temporarily to the front panel. Ensure that the PCB is at right angles to the panel, the three dual gang pots should hold it so, and then solder each of the brackets.

If you have used an enclosure, such as the Bryant and Holt “Joggle” 19” cases, that does not allow you to access all the pot bracket pins once the board is fitted up to it, then only solder the pins you can easily reach from the board's underside. Once these have been soldered remove the board from the front panel and solder the ones along the front edge.

Now remove the board from the front panel if you have not done so already. It's time to fit the switches. The PCB mountable switches should fit quite tightly into their holes on the board. Ensure that you have the three position switch, all the others just have two positions, up and down, fitted in the location marked MODE. Make sure the switch body is flat against the board. Now solder all the pins on each of the switches including the two securing pins to the front. You may need to trim the switches' pins if they stick out too far from the underside of the board.

## Mounting the LEDs

The choice of how you mount the LEDs is up to you. The suggested panel design uses the four LEDs used in the signal meter going up at a forty five degree angle and has the power LED on the central horizontal axis of the panel in line with the pot shafts. It does, however, make it easier if you just fit all the LEDs in a straight line just above the board's top surface. Whichever way you chose you must remember that LEDs are diodes and should be fitted the correct way around or they will not light up. Check the data sheet for the devices you have bought to see which lead is the cathode. The cathode should be soldered to the square pad on the PCB.



*The power on LED.*

The key about mounting an LED to any front panel is to make sure it won't push into the unit when force is applied to it from the front. There are several ways to do this, LED clips, glue (no don't do this), or just relying on the stiffness of the leads. For the second SRE330 prototype I mounted the LEDs onto a bit of stripboard. Stripboard, or Veroboard, is a laminated paper based printed circuit board with copper strips on one side and perforated by a 0.1" grid of holes into which you put the component leads through. You can cut it to size by using a knife to score along the holes on both sides and then snapping the board along the score. The rough edges can be filed down to make a nice tidy little board useful for prototyping. Or fitting LEDs.

The power on LED is fitted to small piece of stripboard secured very firmly by a two way right angled board to board connector. The right angled connector is soldered first to the stripboard and then to the SRE330 main board. The LED is poked through, making sure the leads are correctly polarised, and then soldered in place only when the front panel is fitted and the LED is at the correct depth into the panel's hole. The photo shows how the right angle board to board connector fits into the main board and the stripboard with the black plastic part up against the main board. The copper strips are vertical to allow the LED to connect with the board to board connector.

The four LED signal meter was done similarly and, although fiddly to make, proves to be very

sturdy and effective. This time the right angled board to board connector was soldered up against the stripboard to allow for the lowest LED to fit into the board and have the meter to sit centrally on the panel. Again solder the LEDs only once the panel has been fitted and the LEDs are pushed into their panel holes. Care must be taken to ensure that the board to board connector does not foul the resistor, R39, just behind it.

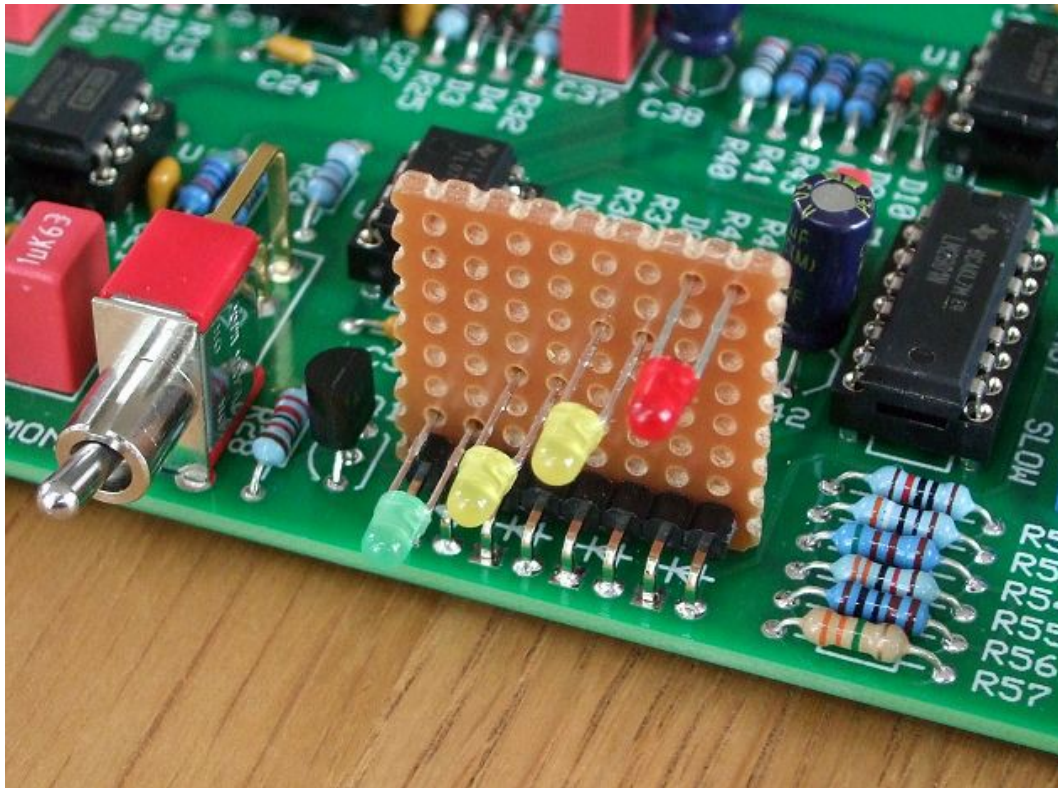

*Using stripboard to make the LED connections.*

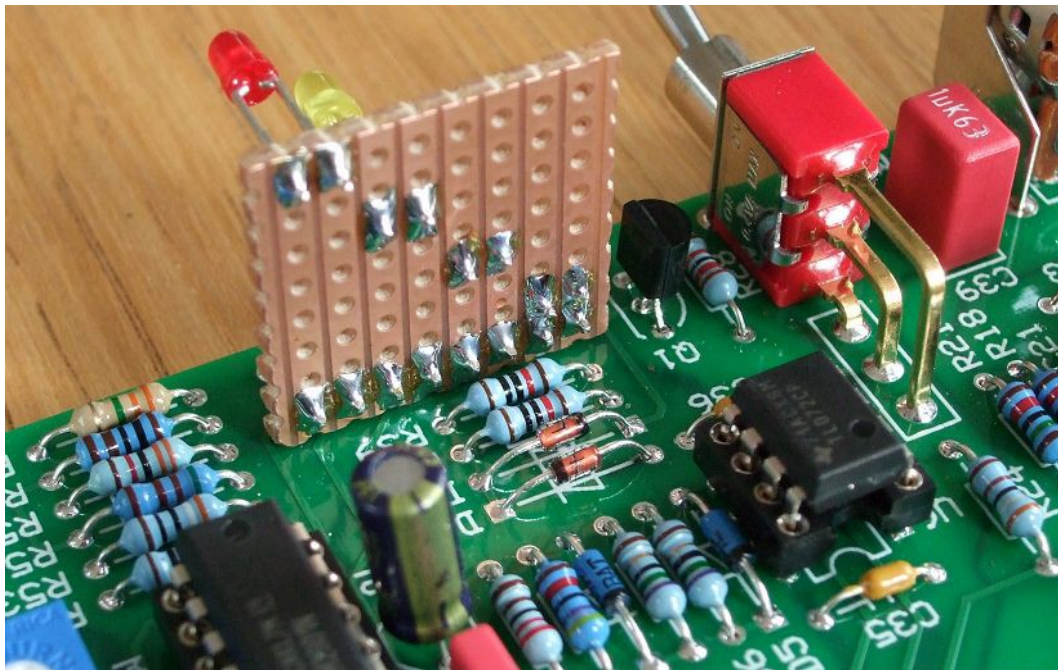

*The stripboard's copper strips go vertically. Care must be taken to ensure that the lower edge of the stripboard is properly filed down so no copper tracks can touch the SRE330 main board surface.*



# The Power Supply

## Safety Warning

The RPSU supply module has been designed to work with isolated low voltage AC inputs only. Connection to any alternating current supply is done at your own risk. Low voltage is classified as being less than 25V with respect to the ground potential. Voltages above this level can, and often are, lethal to living creatures.

Oakley Sound Systems will not advise on building or modifying this board to allow for direct connection to the mains, or other high voltage sources, further to what is provided in this document. Please do not ask me for additional information pertaining to direct mains connections or using internally mounted transformers as I will not give it.

**For safety and legal reasons I cannot recommend powering this board from any other supply than low voltage AC output mains adapters.**

Oakley Sound Systems are not liable for any damages caused by the misuse of this product. It is your responsibility to use this product safely. If you have any doubt about installing a safe power supply, then please do not attempt to do so.

### Single Phase AC output wall wart supply

These are the most common AC output power adapters but increasingly they are getting harder to find particularly at higher output currents. Most wallwart supplies produce DC (direct current) voltages which means they are not suitable for use with the RPSU. Ensure that when you buy a wallwart type adapter it does actually output an AC (alternating current) voltage. Some DC output adapters are confusingly called AC adapters simply because they plug into your AC mains supply.

The SRE330 requires around 650mA or 0.65A from a single phase 15V AC supply. That means you need to find one with **at least** this capability. A 15V 1A device would be perfect, but a 15V 0.5A would not. An 18V AC supply would also work but again at least 0.65A is required.

Quite often you will find power supplies not rated in amps but instead given an overall maximum power rating, or wattage. The maximum amount of current that can be taken is worked out by dividing the power rating in watts by the voltage output. The problem is that you don't often know the exact voltage the device is producing since it does vary a lot from what it says on the device. For example, a 15V supply may well be producing 18V even when at full load. Even so a 15W 15V AC device should work fine. A 10W 15V one however, although in theory should work, in practice it may not.

Ultimately, the proof of whether it works is twofold. It must firstly produce the correct voltage so the RPSU can actually create a stable +/-15V when driving the SRE330. And secondly, the adapter must not get overly warm in use. If you've bought what should be a good adapter but it gets hot or hums loudly when powering the SRE330 then it is not suitable. Another solution must then be sought.

## The recommended option: The Yamaha PA-20

This is a line lump supply and features a fixed 17.5-0-17.5 volt AC output at 0.94A maximum. This means it gives us two AC outputs with a centre tap or mid point reference voltage. So unlike a more common single phase AC adapter output with two leads, this one has three. This means you need to use the Oakley RPSU in full wave rectification mode. That is, both fuses must be fitted and all four of the big rectifier diodes.

The PA-20 is made for Yamaha products and they are available from Yamaha spares departments as well as many music shops, eg. Thomann. These are CE approved and connect to the mains via your local mains connector. They will be different types depending on the country you need them for. It comes with a handy three way plug at the low voltage end that you can use with an appropriate socket. If you wish you can ditch their connector and use your own.

In the UK the line lump's part number is V9812300 and the is around £35. If you are buying these direct from Yamaha and, for some reason, are asked why, the probably best thing to say it is for a MG12/4 mixer.

Once rectified, smoothed and regulated the Yamaha PA-20 can deliver up to 0.52A continuously into both 15V rails.

You should fit both fuses and both should be anti-surge types and rated at 800mA, often written as 800mAT on the fuse body.



*The European version of the PA-20. Other country's units are similar but will have the local mains connector fitted.*

## Grounding Your Case

If you are powering your SRE330 project with an internal mains transformer then you will need to earth your case directly. This is covered in more detail in the section “Using a Mains Transformer” later in this document. If, however, you are powering your case from a wallwart or linelump power supply, the 0V reference point in the SRE330 will be floating with respect to the mains earth. The 0V will then only be 'tied' to mains earth or ground when you connect your audio cables to your studio system.

It is a good idea to connect the metal casing of your project to 0V. This helps keep unwanted signal interference to a minimum. There are variety of ways that the case can be connected to 0V and I have found the best way is to use the sleeve connections of the input and output sockets. Linking R1 on the issue 1 SREIO board, or LK4 on the issue 2 SREIO board, connects all the sleeve connections to the 0V that comes from the SRE330 main board. The sleeve connection on each socket is directly bonded to the threaded bush of the 114BPCX socket. Since these are securely fixed to the case this should mean that the case is also now connected to 0V. To ensure a good connection I use toothed shakeproof washers between the sockets and the inside surface of the rear panel.

The rear panel's mounting screws should then allow the rest of the case to also be connected to 0V. However, this does depend on the type of case, whether it is painted, how it is constructed and so on. It is worth therefore measuring the resistance between parts of the case. If you have no connection, ie. you have a resistance over 10K, between the lower panel and the rear panel it will be worth fitting a wire link in the LK position on the RPSU board. This should tie the RPSU's 0V to the lower panel via the top right hand mounting screw on the RPSU and all the pot brackets on the SRE330 main board via pin 5 of the PS1 connector. How effective it is will depend on how well connected the top right mounting screw is to the bottom panel and how well the pots make contact with the front panel. You may need to scrape any paint from the relevant areas to allow the mounting screw or pot nuts to make good contact.

One has to a little careful when using the word 'ground'. I sometimes talk about local ground and 0V as being the same thing. This is technically incorrect but it is used a lot. I worked at Marconi in the 80s and Soundcraft in the early 90s, and ground and 0V were used interchangeably even by seasoned engineers. We'd talk about chassis ground, dirty ground, signal ground and clean ground. They'd all be connected to 0V somewhere in the system but the term ground was in common usage.

Ground, when used in this way, is then a local common reference connection tied to the 0V of the unit's power supply. It is not the same as mains earth. Indeed, it may not even be tied to mains earth in the unit in question.

Strictly speaking, electrical ground is mains earth and historically it was solely referred to as that, but usage, incorrect or not, has meant a shift in the meaning. Ideally, we should call our common reference connection within our unit as 0V and not use the term ground.

# Linelumps and Wallwarts: Wiring Diagrams

The input power wiring will depend on the type of wallwart or linelump you will be using.

## Standard AC output wallwart

Single phase, two wire, wallwarts or linelumps need to use half wave rectification so the Oakley PSU can generate both positive and negative supplies simultaneously. They only need the terminal's AC1 and 0V1 wired to the power socket. AC2 and 0V2 are left unused.

D9, D10 and F1 are not needed to be fitted to the RPSU although it will do no harm if they are fitted.

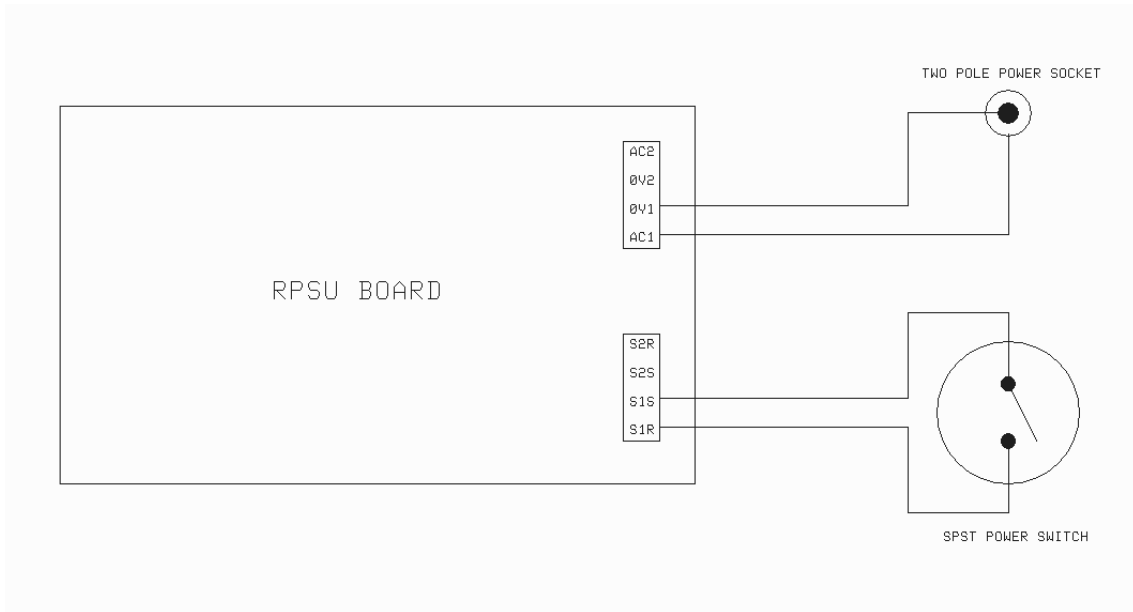

*Connecting to a wallwart with single phase AC output.*

The front panel switch is a single pole single throw (SPST) switch which simply connects S1R and S1S together when switched on.

Only F2 needs to be fitted and it should be rated at 1AT, ie. a one amp anti-surge or time lag fuse.

## Centre tapped wallwarts and linelumps

Centre tapped linelumps like the Yamaha PA-20 will have three wires coming from their connector. It will have two AC outputs and one 0V. Take one of the AC outputs to terminal AC1 and the other AC output to terminal AC2. It should not matter which AC output goes to AC1 or AC2. The 0V should go to the 0V1 terminal. The 0V2 terminal is left unused.

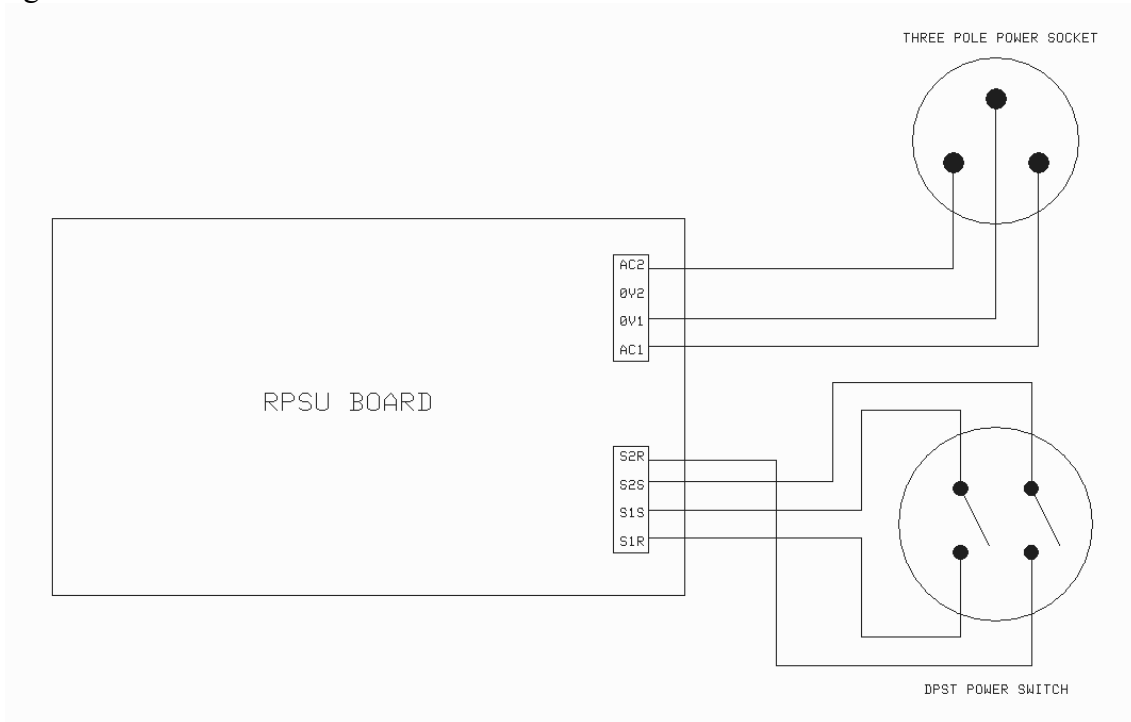

*Connecting to a linelump wiring with centre tapped output, eg. Yamaha PA-20*

The front panel switch is a double pole single throw (DPST) switch which connects S2R and S2S together, and S1R and S1S together, when switched on. Both fuses are fitted and they are both 800mAT anti-surge or time lag types.

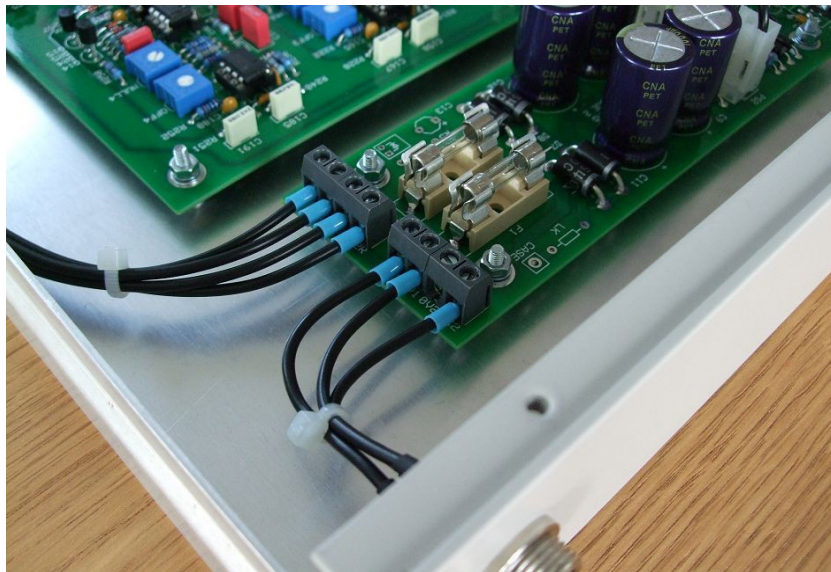

*All power wiring uses 24/0.2 insulated wire. I have also boot lace ferrules on the wire ends that go into the terminal blocks for neatness.*

## Using an Internal Mains transformer

Be afraid, be very afraid...

Some of you old hands will laugh about the level of hysteria that surrounds direct mains connection to DIY projects. However, this fear is more to do with our litigious society than the real danger to the builder. Even so, I have had more than my fair share of high voltage shocks over the years and it is not something I would want any builder to have to experience. It has been purely luck that has saved me in several of those cases.

So I will say again – do not attempt to build a mains transformer into your SRE330, or any other project, without realising that to do so carries a risk of death to either you, or to the person who may inadvertently put their fingers into your half built construction. Furthermore, it is up to you as the builder of such an item to make sure, that once built, the item is safe to use and meets all current safety legislation.

**This is not a complete set of instructions on how to fit a transformer into a piece of electronic equipment. This information is offered only as a guide and should not be considered as your only source of information. No further information, other than that included here, will be provided by myself regarding the construction of mains powered items.**

For powering the SRE330 then the mains transformer's secondaries should be rated:

Voltage: 18-0, 18-0 (dual secondary) or 18-0-18 (single tapped secondary)

Power: At least 25VA

This will give you a power supply that should be theoretically capable of providing just over 400mA to each rail assuming your heatsinking and smoothing capacitors are up to the job.

The transformer secondary voltage is suggested to be 18V. It may be possible to use a 20VA transformer rated at 15V. Most transformers produce more than their stated voltage when drawing less than their maximum current and I have found that 15V toroids always work well here in the UK. The benefit of using a lower secondary voltage is cooler power devices. However, the disadvantage is that you may be running your power supply very close to its lowest operating voltage – particularly if your country's line voltage is less than the expected 230V (or 110V).

Slightly higher transformer secondary voltages can also be tolerated although you need to consider three things:

1. You may need a physically larger transformer for the same output current.
2. The power supply's components, including the smoothing capacitors, should be rated at a high enough working voltage to handle the increased voltage across them.
3. The heatsink, ie. the case, will need to dissipate even more energy because of the greater voltage drop across the regulators.

In the wiring diagram shown I have included a suggested wiring method for connecting up a mains transformer. Not all mains transformers are the same, some have additional windings, others have

tapped windings. I have simply used a single primary, double secondary type for example only.

For the mains side fuse you should use a 500mA anti-surge type. All wiring at mains potential should be adequately insulated, secured well and protected from straying fingers.

There is no need to fit an AC standby switch since you will be fitting a proper mains switch in series with the transformer primary coil. So you should link S1A to S1R, and S2S to S2S, on the RPSU PCB.

Toroidal transformers are in theory much easier to mount than ordinary EI transformers, they simply need one large bolt to secure the various parts provided. However, there are two important considerations involved when mounting a toroidal in a 1U high rack case. The first is that the transformer and the mounting bolt must fit inside the case without the metal mounting bolt or top mounting plate touching the metal case. The mounting bolt must only be in contact with the lower panel. If it touches the top this will short circuit the transformer and it will probably catch fire. Secondly, fitting a large bolt through the lower panel will mean the bolt head will stick out proud from the underside surface, and the case may not now fit into a rack without touching other rack equipment mounted below it. Commercial rack cases that use toroidal transformers often have a upward indented section on the underside panel on which the transformer sits. The hollowed out section can then easily hold the screw head without making the case exceed the 1U height format.

## **Earthing**

Remember it is up to you, the builder of the equipment, to make sure that your item is safe and is built to the required safety standard in your country. These notes are only a guidance and it is up to the reader to establish the exact obligations required in their own country.

It is essential that everything you build, that has both live mains inside and a metal case or panels, has a safety earth fitted. UK legislation requires that any metal panelling should be adequately insulated, ie. double insulated, or connected to earth. Since making a double insulated case is not practical you should ensure that any exposed external metal parts be properly earthed.

The case should be bonded to earth using an M4 screw, toothed washer, washer, solder tag and a securing nut (or two) bolted through the case and then via a thick piece of wire back to the earth tang of the IEC power inlet. It is useful to mount this earth bonding point on the rear panel of the unit. Remember that all other parts of the case must be earthed too. Painted metal parts of the case must be dealt with so that they too are earthed. This may involve using secondary bonding points or scraping back the paint at the appropriate point.

The RPSU board should be securely mounted (using all four mounting holes) onto the earthed casing using appropriate screws and toothed washers. You should also solder a thick wire from the solder pad marked 'CASE' on the RPSU to the earth bonding point on the rear panel.

You will also need to provide earthing to any exposed transformer core. This does not apply to toroidal types but EI types should have their metal frame earthed.

It is possible that by earthing the case and local ground you may introduce earth loops when you connect your mixer to the sockets of the SRE330. The outcome of this is audible humming at 50/60Hz and its harmonics. It is produced by currents travelling down the screen of the connecting cable(s). This can be avoided by careful studio wiring and/or by using balanced audio lines to pipe

signals to and from the unit and mixing desk. Most mixing desks and sound cards will have balanced outputs and inputs.

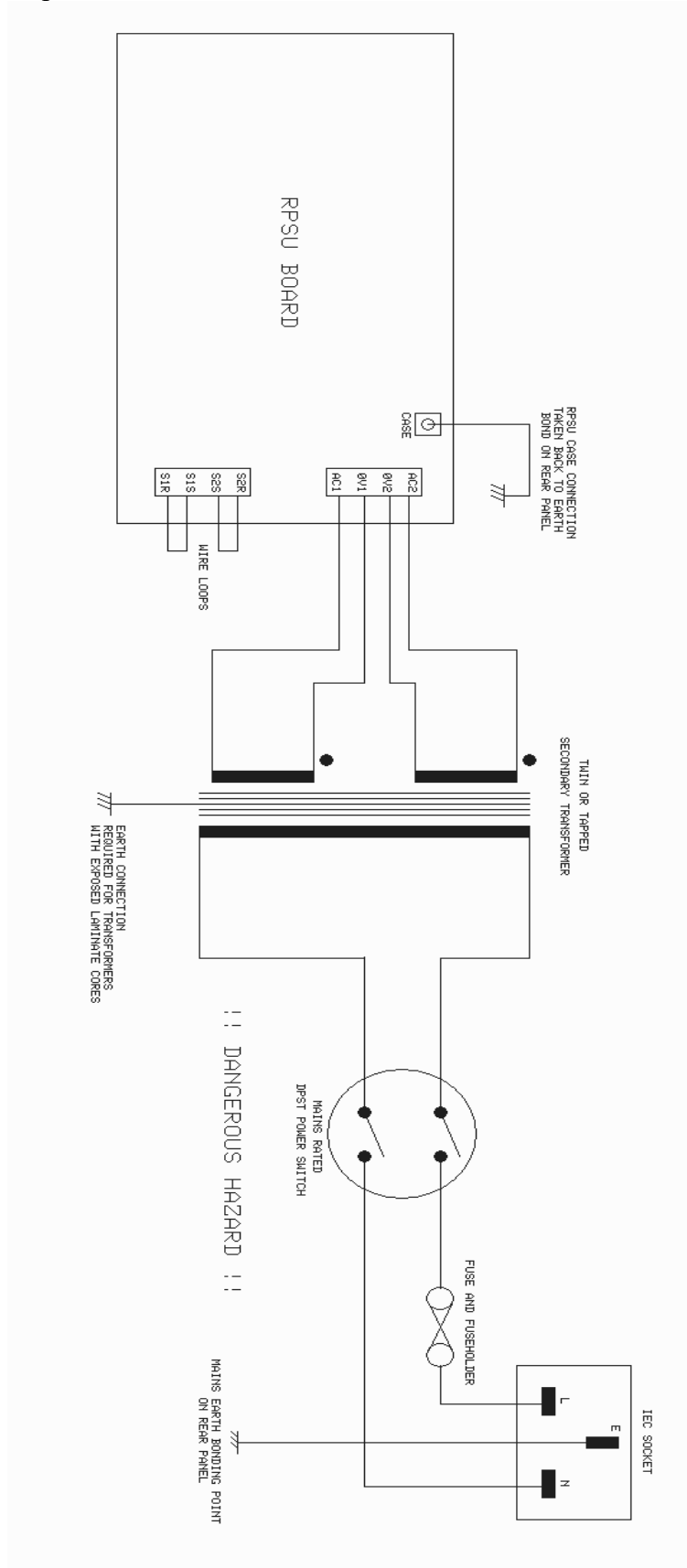

*Mains wiring diagram. For experienced builders only!*



## Attaching the Power Devices



*In this build the two regulators are insulated from the panel with soft red insulating pads.*

The RPSU PCB needs to be fitted to your case metalwork. Use the PCB as a template for the four holes needed for the mounting pillars. The board should be spaced high enough off the panel so as to not short out any of the components' leads should the board be flexed downward. However, they should also not be too long so that the leads from the two regulators can't reach through the board to be soldered. I find an 5 or 6mm spacer works very well.

Now you need to prepare the leads of the two power devices. The three legs need to be bent upwards so that the PCB can be fitted over them. Note that the top surface of the device is marked with the name of the component and it is the flat side on the bottom of the device that will be in contact with the panel. You should be able to see that the leads have a thicker section close to the body of the device. Make a 90 degree bend upwards at the point where the lead thickness changes. Do this for all three legs of the device.

Remove the board from the panel and fit the power devices to the board by poking their legs up through the bottom of the board. Do not solder them but fit the board back into place. Use the hole in each regulator to mark out where you need to drill the mounting hole for the two devices. Now remove the board and regulators. Carefully drill a 3.8 or 4mm hole in the panel for each of the regulators. Clear off any swarf and, twisting with your hand only, use an 8mm drill bit to lightly deburr the edges of the holes. There should be no bumps around the holes.

The regulators are both TO-220 devices. They both need to be fitted to the panel mechanically and thermally but not electrically. That is the metal tab on each device that will be mounted to the panel should not make electrical contact with the metal panel. To achieve both thermal transfer and electrical insulation we use an insulator. These can be made of a 'soft' flexible material in the form of an insulating pad or a rigid thin glass like plate made from mica. If using the mica you will also need to use heat transfer paste. Since the paste is somewhat messy I recommend you use the insulating pads. Both types are normally available in 'mounting kits'. Also in the kit is a mounting bush. This top hat shaped piece of stiff plastic prevents the mounting screw from touching the regulator's metal tab.

Now place the mounting bush into the hole of the power device, with the flange of the bush lying on the top side of the device. Take one of the insulating pads and place it against the rear of the regulator. It should fit flat against the device and the bush should stick out a little allowing you to align the pad correctly.

Now place the power device, bush and pad, flat against the rear of the panel so that the bush fits into the panel hole. Make sure the pad does not slip out of place when you do this. Insert a 10mm M3 screw into the hole from the reverse side of the panel, and fit a spring washer and nut onto the screw but do not tighten. Do the same for the other regulator making sure, of course, that the correct device is in its proper location.

If you have drilled your holes correctly, you should find that when the power supply PCB is lowered back its four mounting screws, you can coax the power devices' legs through the respective solder pads on the board. Now tighten the four nuts holding the RPSU board in place. You should have a flat washer and shakeproof washer under each nut. Gently tighten the screws holding the power devices. Do not tighten them too much as this will crush the insulating pad. Once secured you can solder the regulators' leads from the top side of the board and clip off any excess lead lengths.

If the bottom panel of your case, or the power device's mounting tab, is too thin, you may find that the insulating bushes are too long to allow the use of countersink screws. Countersink screws are often better since they sit flush with the underside of the rack case. However, if the insulating bush protrudes too far into the hole it may not allow a countersink screw to seat properly. Tightening the screw will then inevitably crack the insulating bush and possibly allow the screw to make contact with the power device's metal tab. In this scenario it may be better to use standard pan head screws with no countersunk holes and accept that they stick out a little from the underside of the case. Alternatively, you could use a 1.5mm or 2mm thick aluminium shim plate to go between the case panel and the power devices. The size of such a plate is not crucial but 30mm by 60mm would be appropriate. A Scheaffer fpd file can be found for such a shim plate on the project webpage.

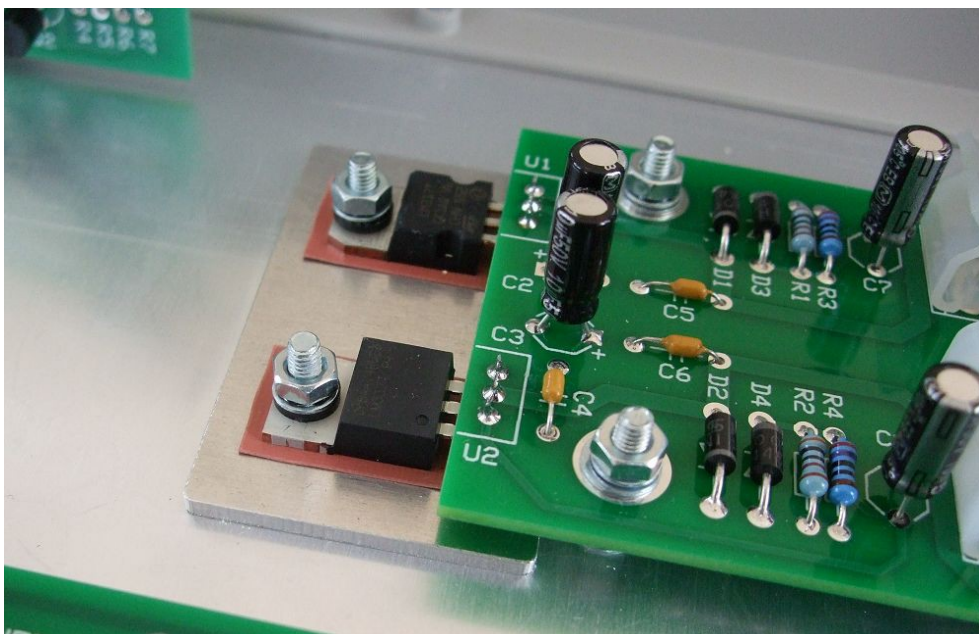

*Using an aluminium shim beneath the power devices so that the long part of the insulating bushes will not be damaged by using countersunk mounting screws.*

## Interconnections

If you are building the SRE330 in the suggested way with all three Oakley PCBs you will need three sets of interconnects that link the boards together.

The 16-way IDC flat ribbon cable connects the SREIO and SRE330 main board together. It carries balanced audio signals and 0V.

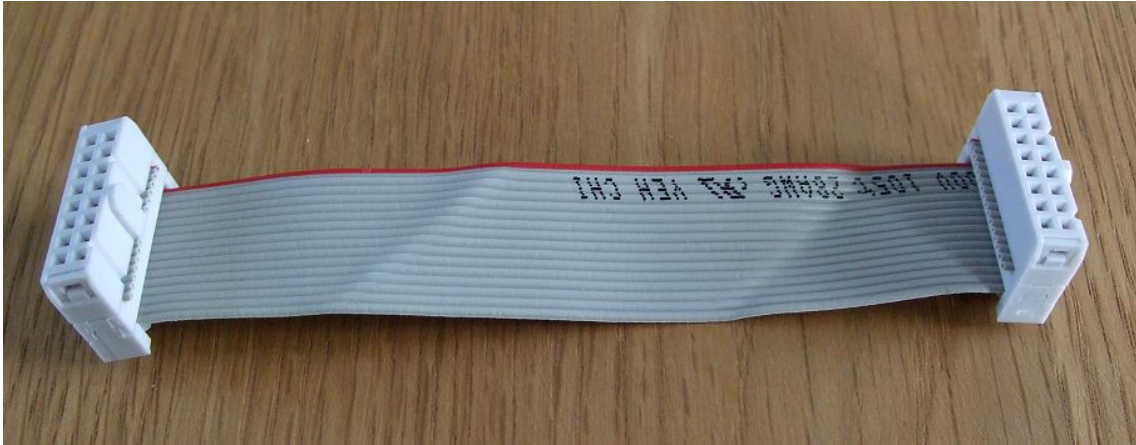

The IDC cable should be made so that pin 1 goes to pin 1, pin 2 goes to pin 2, etc. Note the polarising lugs on each of the connectors in the photograph above – they both point right. The red edge denotes the pin one connection. Here I have used connectors that have a strain relief fitted which requires the cable to be folded back under the connector before the strain relief bar is clicked into place.



The power connections are made with 24/0.2 cable fitted to Molex 0.156" KK crimp housings. You can use MTA type connections if you prefer. Again both cables are made so that pin 1 goes to pin 1. The three way connection only uses two of the connections. Pin 2 is NOT connected. With the five

way connection, all five positions are used.

If you are wiring the sockets direct to the SRE330 main board without using the SREIO you will have to make your connections to the array of solder pads that make up IN1. This is not particularly easy as IN1 is designed to be a 16 way 0.1" IDC header, however, it can be done with care. I recommend that you use wire no larger than 7/0.2 and tin the bare end of the wire before you insert the wire into the hole and solder from the underside.

If you have bought Switchcraft 114BPC sockets you will see that they have five terminals or connections. One is the earth or ground tag and this is found on the bevelled corner of the socket housing. Another is the 'hot' signal tag which will be connected to the tip of the jack plug when it is inserted. Another is the 'cold' signal tag which is connected to the ring of the inserted jack plug. The remaining two terminals are the normalised tags, or NC (normally closed) tags. The NC tag is internally connected to the associated signal tag when a jack is not connected. These two NC connections are automatically broken when you insert a jack.

Once fitted to the rear panel the ground tags of each socket can be all connected together with solid wire. I use 0.91mm diameter tinned copper wire for this job. It is nice and stiff, so retains its shape. A single piece of insulated wire can then be used to connect those connected earth tags to the 0V of your power supply. If you are using an RPSU the 0V is found at pin 2 of the PS2 header on the RPSU.

You should join the hot NC lug of the input (right) socket to the hot signal lug of the input (left) socket. You should also join the cold NC lug of the input (right) socket to the cold signal lug of the input (left) socket.

All the other connections are connected to the signal or NC lugs of the four sockets, and these go to the IN1 header on the main board. IN1 is a 2 x 8 (16 way) header. Pin 1 is designated by a square pad, that is the lower left hand pad of IN1. The numbering is such that all odd numbers are nearest to the front of the board, and all the even numbers are closest to the back edge of the board. All the even numbered pads are connected to main board's 0V.

The table below show the connections you need to make between the main board and the sockets:

<i>Pin</i>	<i>Pad name</i>	<i>Socket Name</i>	<i>Lug Type</i>
Pin 1	INPUT_L_A	Input (left)	Cold (signal)
Pin 2	0V	Input (left)	Cold (NC)
Pin 3	INPUT_L_B	Input (left)	Hot (signal)
Pin 4	0V	Input (left)	Hot (NC)
Pin 5	INPUT_R_A	Input (right)	Cold (signal)
Pin 7	INPUT_R_B	Input (right)	Hot (signal)
Pin 9	OUTPUT_L_H	Output (left)	Hot (signal)
Pin 11	OUTPUT_L_C	Output (left)	Cold (signal)
Pin 13	OUTPUT_R_H	Output (right)	Hot (signal)
Pin 15	OUTPUT_R_C	Output (left)	Cold (signal)

Note that both signal lugs of the input (left) socket will now have two wires connected to each of them. One wire to the main board and the other to the associated NC lug on the input (right) socket. The NC lugs on both output sockets are not connected to anything.

## Initial Testing

It would be prudent to test the power supply first before applying power to either the SREIO or SRE330 main boards. So remove any interconnections between the RPSU board and the other two boards. Apply power and switch on.

Measure the voltage between pin 1 and pin 2 of PS1. You should have a voltage somewhere between +15V and +15.5V. Pin 2 and pin 3 of PS1 are both connected to 0V, the SRE330's common reference point. Now measure between pin 4 and pin 3. You should have a negative voltage between -15V and -15.5V. No part should be getting hot.

To be sure things are fine with the RPSU, leave the device on and measure the voltages again after ten minutes. They should be roughly the same as they were before. Again no part should be getting hot.

Switch off and wait about a minute. Connect the SREIO board. Switch on and after less than a second, you should hear a click from the relay as the coil inside it is energised. Switch the unit off and after a few seconds you should hear another click as the relay turns off. It should be noted that once the SRE330 main board is connected the relay turn off time will be much shorter, but the turn on time is the same.

Now it is time to connect the main board. As you turn it on for the first time you should notice all four LEDs on the signal meter light up briefly and then go out in turn, the red first and the green last. If any remain lit then you have a problem. The power on LED should light up and stay on for as long as the unit is switched on.

Check that the power supply is still producing between +/-15V and +/-15.5V.

Leave the unit on and check that no device is getting hot. A few ICs will get warm but none should be too hot to touch. Check the power devices on the power supply. These should be getting warm after a few minutes but neither should be getting hot. If they are, you may need to look at your heatsinking arrangements.

The unit should pass and affect audio even without calibration. However, an uncalibrated SRE330 may produce some unwanted audio artefacts, so the first thing to do is to check that the dry signal pathway is working correctly.

Connect a 5V peak sawtooth or triangle wave at around 220Hz to the left input socket. The signal meter will light up as you turn up the input level. The red LED should be lit when the input level is around half way.

Set the balance pot to dry and the input level so that the second yellow LED on the signal meter just lights up. Monitor the audio output from the left hand output. Turn up the output level and you should hear your audio input. Check the right hand output and this too should have the same audio signal.

Now remove the input from the left hand input socket and use the right hand input instead. The audio output should only be heard from the right hand output and now not the left hand output socket. This is because only inserting a jack plug into the left input also sends that signal to the right input automatically.

You should now calibrate your unit and the instructions for doing this are in the User Manual.

## Final Comments

If you have any problems with the module, an excellent source of support is the Oakley Sound Forum at [Muffwiggler.com](http://Muffwiggler.com). I am on this group, as well as many other users and builders of Oakley modules.

I'd love to hear about what you have done with your module. Please do post pictures of your finished module at the Oakley Sound forum on Muffwiggler.

If you are in the EU and can't get your project to work, then Oakley Sound Systems are able to offer a 'get you working' service. If you wish to take up this service please e-mail me at my contact e-mail address found on the website. I can service either fully populated PCBs or whole modules. You will be charged for all postage costs, any parts used and my time at 25GBP per hour. Most faults can be found and fixed within one hour, and I normally return modules within a week. The minimum charge is 25GBP plus return postage costs.

If you have a comment about this user guide, or have found a mistake in it, then please do let me know. But please do not contact me directly with questions about sourcing components or general fault finding. Honestly, I would love to help but I do not have the time to help everyone individually by e-mail. The forum is the best place to ask these sorts of questions.

Last but not least, can I say a big thank you to all of you who helped and inspired me. Thanks especially to all the nice people on Muff's Forum and the SynthDIY and Analogue Heaven mailing lists.

***Tony Allgood at Oakley Sound***

Cumbria, UK

© October 2017 – updated September 2020

No part of this document may be copied by whatever means without my permission.